

# INSTALLATION

---

If you have an outlet to the outside, your cooker hood can be connected as below picture by means of an extraction duct (enamel, aluminum, flexible pipe or non-flammable material with an interior diameter of 150mm)

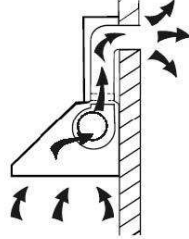

1. Before installation, turn the unit off and unplug it from the outlet.

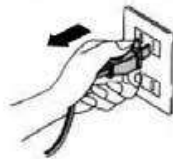

2. The cooker hood should be placed at a distance of 65~75cm above the cooking surface for best effect.

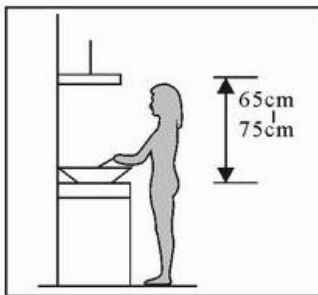

Pic1

3. Drill a hole in the cupboard, with hole wide 865\*265(mm) for 90cm, hole wide 715\*265(mm) for 75cm or hole wide 490\*265(mm)for 52cm. Refer to pic below. Make sure the distance between the edge of the hole and the edge of the cupboard edge is at least 35mm.

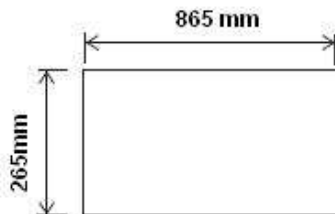

90CM

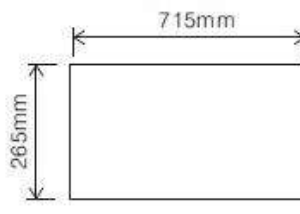

75CM

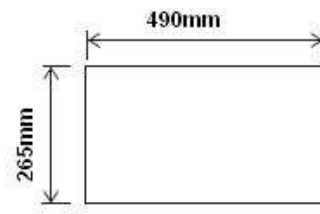

52CM

4. Remove the aluminum filter and remove the two front panel screws.
5. Use a screwdriver to secure the 8pcs ST4\*18 screws to the cabinet.
6. Replace the front panel with the two screws and replace the filter.

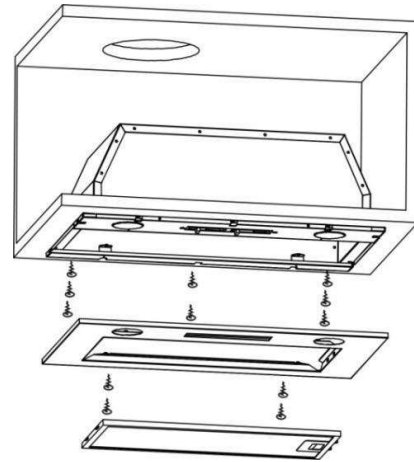

Note: The expansion pipe is not included in the product.

**WARNING:**



- For safety reason, please use only the same size of fixing or mounting screw which are recommended in this instruction manual.
- Failure to install the screws or fixing device in accordance with these instructions may result in electrical hazards.